



# Installation Guide for Extender & Extender with Offset

4 Commerce Way  
Arden, NC 28704  
Phone: (828) 676-1700 - Fax: (828) 676-2330  
[WWW.HICKMANEDGESYSTEMS.COM](http://WWW.HICKMANEDGESYSTEMS.COM)

## Installation Guide for Extender

(With & Without Offsets)



ANSI/SPRI/FM4435/ES-1 TESTED

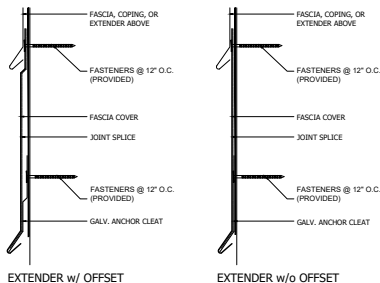

**NOTES:**

- #1 - Isolate all metal parts from ACQ treated wood or other galvanically incompatible material with appropriate membrane material.
- #2 - Appliance attachments, such as lightning rods, signs, or antennae that penetrate the edge system, induce a galvanic reaction, or otherwise compromise the effectiveness of the roof edge system, shall be eliminated or isolated to prevent problems per ANSI/SPRI/FM4435/ES-1. Lightning protection systems for example must not be directly affixed to the product provided by Hickman Edge Systems. Consult Hickman Edge Systems for alternative attachment suggestions.

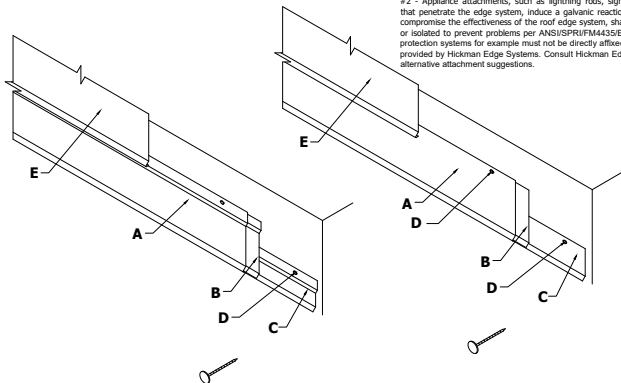

**A. Formed Fascia Cover**

**B. Concealed Joint Splice**

**C. Galvanized Anchor Cleat**

**D. Fastener**

at 12" o.c. (6" from ends) @  
Pre-Punched Holes

**E. Fascia, Coping, or Extender**  
(Product may vary)

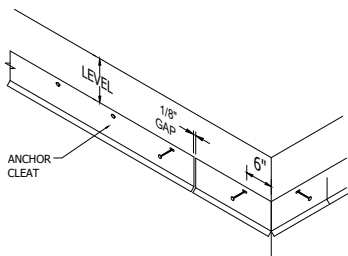

### STEP 1: Installing Anchor Cleat

Place the top edge of the anchor cleat level on the wall face and press cleats securely in position and secure through the pre-punched holes using the mechanical fasteners provided. For miter application, fit into corner as required to maintain a continuous anchor cleat line. Then secure at a min. of 6" in each direction from the corner or closer at special conditions. Allow 1/8" gap between sections for thermal movement.

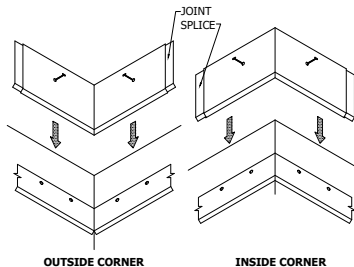

### STEP 2: Installing Fascia Miters

Locate fascia miters and joint splice for the appropriate corners. Place a joint splice under each end of the miter sections. Install the miter by hooking the drip of the fascia onto the kick out of the cleat and rotate back until the fascia is flush with the wall face. Fasten through the pre-punched holes using the mechanical fasteners provided.

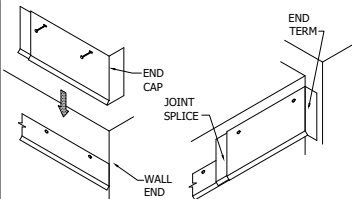

### STEP 3: Installing Fascia End Caps and End Terms

Install the fascia by hooking the drip of the fascia onto the kick out of the cleat and rotate back flush with the wall face. Fasten through the pre-punched holes using the mechanical fasteners provided.

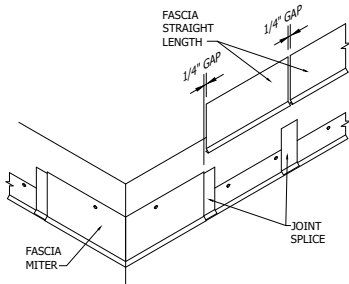

### STEP 4: Installing Fascia Straight Lengths

Place a concealed joint splice on the opposite end of the installed miter or end cap. Install the fascia by hooking the drip of the fascia onto the kick out of the cleat and rotate back flush with the wall face. Fasten through pre-punched holes using the mechanical fasteners provided. **Allow 1/4" gap between fascia sections for thermal expansion.** Consider lengths of all straight pieces prior to cutting to avoid creating relatively short sections of fascia adjacent to full length section.

**Note: There should be a joint splice at every joint.**

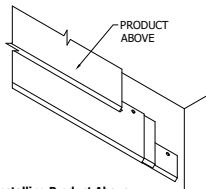

### STEP 5: Installing Product Above

Install product above fascia per manufacturer's installation instructions.