

PermaSnap & PermaSnap Premier Coping

Continuing a tradition of innovative, rigorously tested roof edge systems, PermaSnap coping products are a fine complement to your building's natural aesthetics for parapet conditions. Available in variety of options, including standard and custom colors as well as anodized finishes, PermaSnap coping is exactly what you need for your building: the right design, the right quality, the right price—and easy to install.

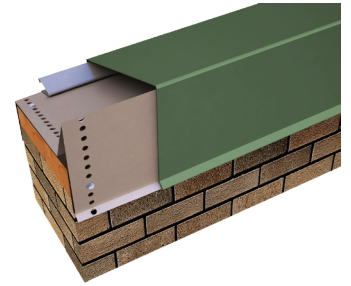

PermaSnap Premier Coping (Tapered)

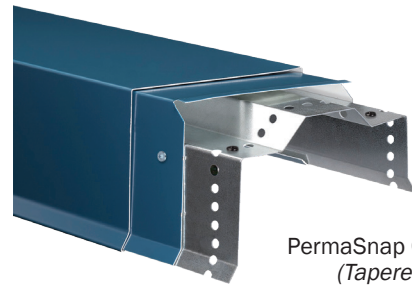

PermaSnap Coping (Tapered)

PermaSnap Premier Coping (Tapered)

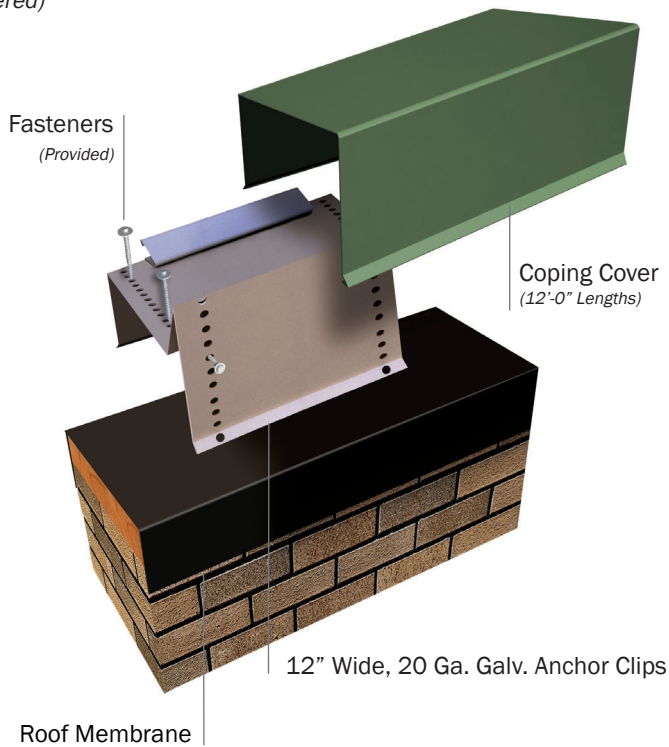

PermaSnap At-A-Glance

- » 20 Year, 120 MPH Wind Warranty
- » ANSI/SPRI/FM 4435/ES-1 Tested
- » FM Approved for Wind Uplift Protection*
- » Miami-Dade County Approved*
- » Custom Fabricated for Specific Req's
- » Easy Install = Decreased Labor Costs

*See chart on page 2

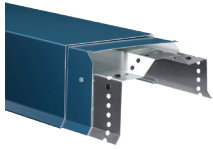
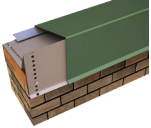
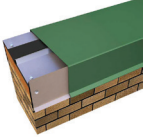
PRODUCT NAME	VERSIONS	PROFILE	WIND WARRANTY	COVER MATERIALS	ANCHOR CHIP/CLEAT MATERIAL	TESTED WALL SIZE	ANSI/SPRI/FM 4435/ES-1 TESTED	FM APPROVED	MIAMI-DADE COUNTY APPROVED
 PERMASNAP COPING	Tapered Flat Existing Slope	Inside Flush; Outside Drip	20 Year, 120 MPH	24 ga. 22 ga. .040" .050" .063"	20 ga. Anchor Clip	Max 16"	X		
 PERMASNAP PREMIER COPING	Tapered Flat Existing Slope	Drip	20 Year, 120 MPH	24 ga. 22 ga. .040" .050" .063"	20 ga. Anchor Clip	Max 16"	X	X	X
 PERMASNAP CONTINUOUS CLEAT COPING	Tapered Flat Existing Slope	Drip	20 Year, 120 MPH	24 ga. 22 ga. .040" .050" .063"	20 ga. Cleat	Max 24"	X	X	X

10 Express Colors for Quick Shipping

Express, standard, and premium colors and finishes are available to meet your job requirements and includes a 30-year Kynar 500® finish warranty on coil-coated standard colors. Custom colors are also available. For the most accurate color representation, contact us to request a paint chip.

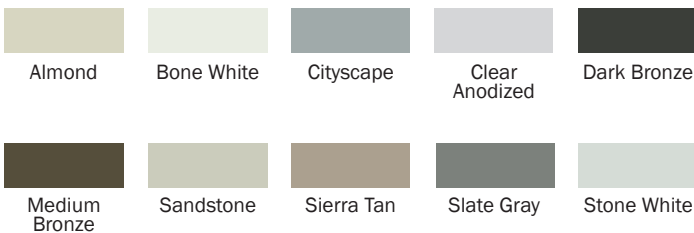

Also available in Mill Finish.

Easy and Efficient Installation

- » Simple, snap-on design with no crimping
- » Provided in 12'-0" lengths for quicker installation and lower labor costs
- » Pre-punched slotted fastening holes to ensure proper attachment and thermal movement
- » Prefabricated miters and accessories to prevent need for field fabrication



4 Commerce Way | Arden, NC 28704
 (828) 676-1700 | www.hickmanedgesystems.com
 Copyright ©2022. All rights reserved.

